

BOSE[®]



CineMate[®] 130

home theater system

Owner's Guide | Guía del usuario | Notice d'utilisation

Important Safety Information

Please read this owner's guide carefully and save it for future reference.



The lightning flash with arrowhead symbol within an equilateral triangle alerts the user to the presence of uninsulated, dangerous voltage within the system enclosure that may be of sufficient magnitude to constitute a risk of electric shock.



The exclamation point within an equilateral triangle alerts the user to the presence of important operating and maintenance instructions in the owner's guide.



WARNINGS:

- To reduce the risk of fire or electric shock, do not expose this product to rain or moisture.
 - Do not expose this apparatus to dripping or splashing, and do not place objects filled with liquids, such as vases, on or near the apparatus. As with any electronic products, use care not to spill liquids into any part of the product. Exposure to liquids may create a failure and/or fire hazard.
 - Replace only with a AA (IEC LR06) alkaline battery (or batteries).
 - Do not place naked flame sources, such as lighted candles, on or near the product.
-



CAUTIONS:

- Do not make unauthorized alterations to the product; doing so may compromise safety, regulatory compliance, system performance, and may void the warranty.
 - Long-term exposure to loud music may cause hearing damage. It is best to avoid extreme volume when using headphones, especially for extended periods.
-



WARNING:

Contains small parts which may be a choking hazard. Not suitable for children under age 3.



WARNING:

This product contains magnetic material. Contact your physician if you have questions on whether this might affect the operation of your implantable medical device.

NOTES:

- The product label is located on the bottom of the console.
- Where the mains plug or appliance coupler is used as the disconnect device, such disconnect device shall remain readily operable.
- This product must be used indoors. It is neither designed nor tested for use outdoors, in recreational vehicles, or on boats.
- The speaker wire and interconnect cables included with the system are not approved for in-wall installation. Please check your local building codes for the correct type of wire and cable required for in-wall installation.



Bose Corporation hereby declares that this product is in compliance with the essential requirements and other relevant provisions of Directive 1999/5/EC and all other applicable EU directive requirements. The complete declaration of conformity can be found at: www.Bose.com/compliance

Important Safety Information

Important Safety Instructions

1. Read these instructions.
2. Keep these instructions.
3. Heed all warnings.
4. Follow all instructions.
5. Do not use this apparatus near water.
6. Clean only with a dry cloth.
7. Do not block any ventilation openings. Install in accordance with the manufacturer's instructions.
8. Do not install near any heat sources, such as radiators, heat registers, stoves, or other apparatus (including amplifiers) that produce heat.
9. Protect the power supply or cord from being walked on or pinched, particularly at plugs, convenience receptacles, and the point where they exit from the apparatus.
10. Only use attachments/accessories specified by the manufacturer.
11. Unplug this apparatus during lightning storms or when unused for long periods of time.
12. Refer all servicing to qualified service personnel. Servicing is required when the apparatus has been damaged in any way: such as power supply or cord is damaged; liquid has been spilled or objects have fallen into the apparatus; the apparatus has been exposed to rain or moisture, does not operate normally, or has been dropped.

Note: This equipment has been tested and found to comply with the limits for a Class B digital device, pursuant to Part 15 of the FCC Rules. These limits are designed to provide reasonable protection against harmful interference in a residential installation. This equipment generates, uses, and can radiate radio frequency energy and, if not installed and used in accordance with the instructions, may cause harmful interference to radio communications. However, there is no guarantee that interference will not occur in a particular installation. If this equipment does cause harmful interference to radio or television reception, which can be determined by turning the equipment off and on, the user is encouraged to try to correct the interference by one or more of the following measures:

- Reorient or relocate the receiving antenna.
- Increase the separation between the equipment and receiver.
- Connect the equipment into an outlet on a circuit different from that to which the receiver is connected.
- Consult the dealer or an experienced radio/TV technician for help.

Changes or modifications not expressly approved by Bose Corporation could void the user's authority to operate this equipment.

This device complies with part 15 of the FCC Rules and Industry Canada license-exempt RSS standard(s). Operation is subject to the following two conditions: (1) This device may not cause harmful interference, and (2) this device must accept any interference received, including interference that may cause undesired operation.

This Class B digital apparatus complies with Canadian ICES-003.

CAN ICES-3 (B) / NMB-3 (B)

This device complies with FCC and Industry Canada RF radiation exposure limits set forth for general population. It must not be co-located or be operating in conjunction with any other antennas or transmitters.

The temperature range of this product is 32°F (0°C) to 113°F (45°C).



This symbol means the product must not be discarded as household waste, and should be delivered to an appropriate collection facility for recycling. Proper disposal and recycling helps protect natural resources, human health and the environment. For more information on disposal and recycling of this product, contact your local municipality, disposal service, or the shop where you bought this product.

Important Safety Information

Names and Contents of Toxic or Hazardous Substances or Elements						
	Toxic or Hazardous Substances and Elements					
Part Name	Lead (Pb)	Mercury (Hg)	Cadmium (Cd)	Hexavalent (CR(VI))	Polybrominated Biphenyl (PBB)	Polybrominated diphenylether (PBDE)
PCBs	X	0	0	0	0	0
Metal parts	X	0	0	0	0	0
Plastic parts	0	0	0	0	0	0
Speakers	X	0	0	0	0	0
Cables	X	0	0	0	0	0

O: Indicates that this toxic or hazardous substance contained in all of the homogeneous materials for this part is below the limit requirement in SJ/T 11363-2006.

X: Indicates that this toxic or hazardous substance contained in at least one of the homogeneous materials used for this part is above the limit requirement in SJ/T 11363-2006.

Please complete and retain for your records:

Serial numbers can be found on the Acoustimass® module's connector panel and on the packaging for the remote control.

Module serial number: _____

Remote serial number: _____

Console serial number: _____

Soundbar serial number: _____

Purchase date: _____

We suggest you keep your receipt with this owner's guide.

Blu-ray Disc™ and Blu-ray™ are trademarks of the Blu-ray Disc Association.

The terms HDMI and HDMI High-Definition Multimedia Interface, and the HDMI Logo are trademarks or registered trademarks of HDMI Licensing LLC in the United States and other countries.”

 **DOLBY** Manufactured under license from Dolby Laboratories. Dolby and the double-D symbol are trademarks of Dolby Laboratories.

 For DTS patents, see <http://patents.dts.com>. Manufactured under license from DTS Licensing Limited. DTS, the Symbol, & DTS and the Symbol together are registered trademarks, and DTS Digital Surround is a trademark of DTS, Inc. ©DTS, Inc. All Rights Reserved.

SoundTouch and the wireless note design are trademarks of Bose Corporation in the U.S. and other countries.

Wi-Fi is a registered mark of the Wi-Fi Alliance.

©2014 Bose Corporation. No part of this work may be reproduced, modified, distributed, or otherwise used without prior written permission.

Introduction

About your CineMate® 130 home theater system.....	7
System Features.....	7
Introducing SoundTouch™ from Bose®	7
Unpacking the system.....	8
Placement guidelines.....	9

Setting Up the Acoustimass® Module

Attaching the rubber feet to the Acoustimass module	10
Connecting the Acoustimass module to power	11

Setting Up the Console

Connecting the console to your TV's HDMI™ ARC connector	12
TVs without an HDMI™ ARC connector	13
Use a secondary connection in the following configurations.....	13
Connecting the console to other sources	13
Connecting to non-HDMI™ compatible sources	14
Audio-only sources	14

Setting Up the Soundbar

Connecting the soundbar	15
Attaching the optional extension feet to the soundbar	16
Wall mounting the soundbar	16

Connecting the System to Power

Connecting the soundbar to power	17
Connecting the console to power.....	17

Starting Up the System

Installing the remote control's batteries	18
Powering on the system.....	18

Contents

Finishing Setup

Checking for sound.....	19
Changing the language on the console.....	19
Running the ADAPTIQ® audio calibration.....	20

Using the System

Remote control buttons.....	21
Programming the universal remote control	22
Consumer Electronics Control	22
Test your HDMI™-connected sources for CEC.....	23
Program the remote to control your source.....	24
Source selection	25
Select a source connected to the Bose® system	25
Select a source connected to your TV	25
Universal source buttons and console connectors.....	25
Adjusting the volume	26
Function buttons.....	26
Programming a non-Bose remote control.....	26

Getting System Information from the Display

Understanding messages on the display	27
Using the System menu.....	27
Error messages	29
Acoustimass module status indicator	29

Care and Maintenance

Troubleshooting	30
If your console cannot find the Acoustimass® module.....	31
Factory reset the system	32
Reset a source button on the remote control.....	32
Service connectors on the Acoustimass® module.....	32
Cleaning.....	33
Customer service.....	33
Limited warranty	33
Technical information.....	33

About your CineMate® 130 home theater system

The CineMate 130 system delivers spacious, detailed sound from one slim soundbar.

System Features

- Advanced Bose audio processing provides natural and lifelike sound.
- ADAPTiQ® audio calibration optimizes sound quality.
- Display provides access to system settings and information.
- HDMI™ connectivity allows easy setup and ensures high-quality audio from your connected sources.
- Supports Consumer Electronics Control (CEC).
- Programmable universal remote can control your TV, cable/satellite box and other connected sources.
- Hideaway wireless Acoustimass® module provides impactful bass sound.
- Soundbar can be mounted on the wall (kit available separately).
- Supports the SoundTouch™ wireless adapter (available separately).

Introducing SoundTouch™ from Bose®

With the SoundTouch™ wireless adapter (available separately), you can stream Internet radio, music services (where available) and your music library. If you have Wi-Fi® at home, you're ready to enjoy your favorite music in any room you want.

Key Benefits

- Enjoy wireless access to Internet radio, music services and your music library.
- Stream your favorite music easily with personalized Presets.
- Works with your existing Wi-Fi® network.
- Free SoundTouch™ app for your computer, smartphone or tablet provides more powerful control.
- Simply add additional systems at any time for a multi-room listening experience.
- Wide selection of Bose audio systems lets you choose the right solution for any room.

Introduction

Unpacking the system

Carefully unpack the carton and confirm that the following parts are included:

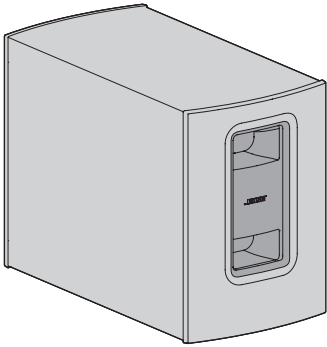

Acoustimass® module

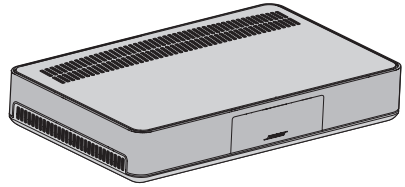

Console

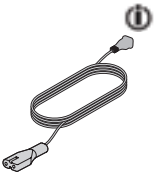

Acoustimass power cord

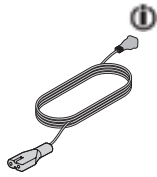

Console power cord

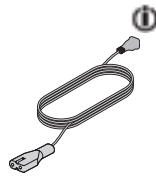

Soundbar power cord

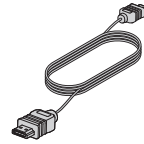

HDMI™ cable

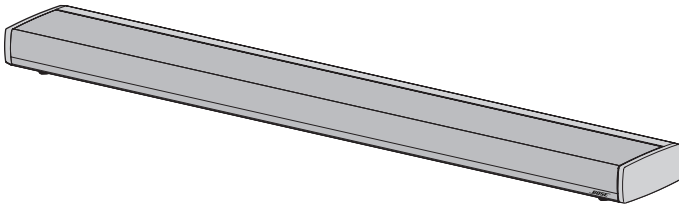

Soundbar



Speaker cable



Universal remote control

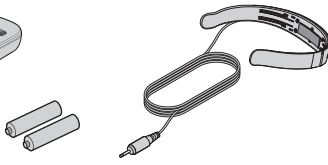

ADAPTIQ® headset



Rubber feet

 The appropriate power cords for your region are supplied.

Note: If part of the system is damaged, do not use it. Contact your authorized Bose® dealer or Bose customer service. Refer to the contact sheet in the carton.

Placement guidelines

To avoid wireless interference, keep other wireless equipment away from the system. Place the system outside of and away from metal cabinets, away from other audio/video components and away from direct heat sources.

Acoustimass® module	<ul style="list-style-type: none"> • Stand the Acoustimass module on its rubber feet along the same wall as your TV, or along any other wall in the front third of the room. • Choose a stable and level surface. Vibration can cause the Acoustimass module to move, particularly on smooth surfaces like marble, glass or highly polished wood. • Make sure there is an AC (mains) outlet nearby.
Soundbar	<ul style="list-style-type: none"> • Place the soundbar in front of your TV. • Do not place the soundbar inside a cabinet. • Make sure there is an AC (mains) outlet nearby.
Console	<ul style="list-style-type: none"> • Place the console near your TV. Do NOT place the TV on top of your console. • Make sure there is an AC (mains) outlet nearby.
SoundTouch™ wireless adapter (available separately)	<ul style="list-style-type: none"> • Place the SoundTouch™ wireless adapter within 1–6 ft. (.3–1.8 m) of the console. • If you have the SoundTouch™ wireless adapter, you can begin set up. Refer to the SoundTouch™ wireless adapter's owner's guide for more information. <p>Note: Do not connect the adapter to the console until prompted by the SoundTouch™ app.</p>

Sample system placement

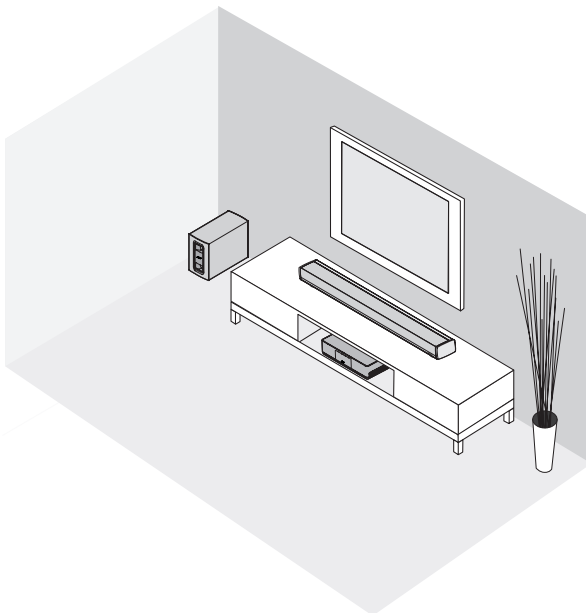

Setting Up the Acoustimass® Module

Attaching the rubber feet to the Acoustimass module

Attach the rubber feet to the Acoustimass module to protect your floor.

1. Turn the Acoustimass module upside down onto a soft surface to protect it from being damaged.
2. Attach the rubber feet to the bottom of the Acoustimass module.

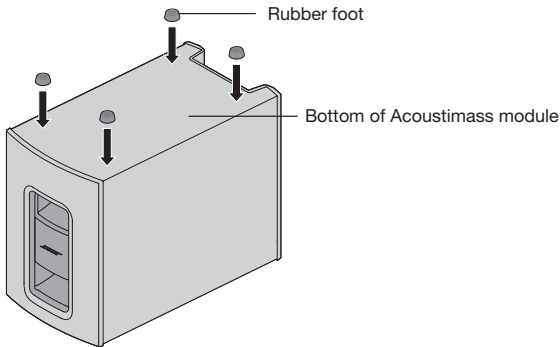

3. Place the Acoustimass module on its feet.

Caution: Do not place the Acoustimass module on its front, back end, side or top when in use.

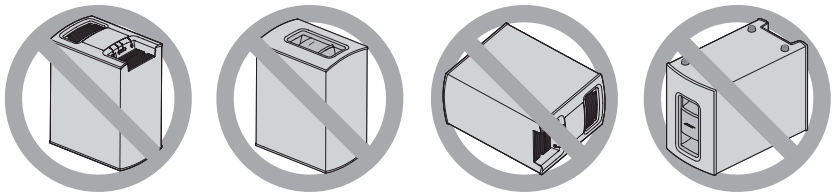

4. Remove all protective films. These may affect acoustic performance if left in place.

Connecting the Acoustimass module to power

1. Plug the power cord into the Power connector on the Acoustimass module.

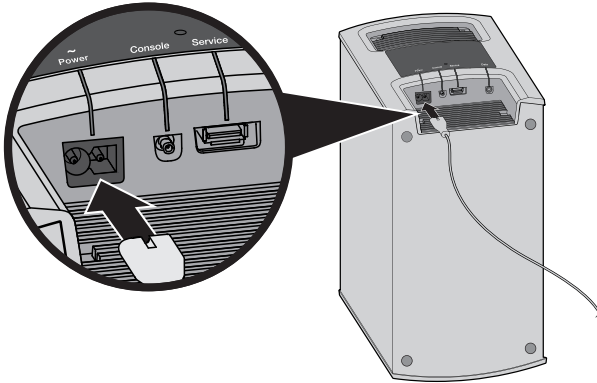

2. Plug the power cord into an AC (mains) outlet.

Setting Up the Console

Connecting the console to your TV's HDMI™ ARC connector

Use the Bose® HDMI cable to connect the console to your TV.

1. Disconnect your HDMI-connected sources, such as a cable/satellite box, DVD or Blu-ray Disc™ player or game system, from your TV.
2. Insert one end of the Bose® HDMI cable into the **TV** connector on the console.

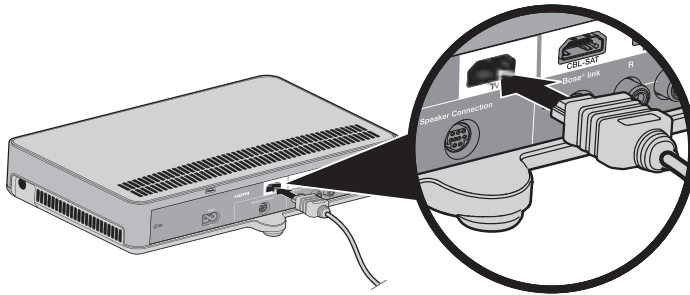

3. Insert the other end of the HDMI cable into your TV's **HDMI** connector.

Note: Use your TV's HDMI connector labeled **ARC** or **Audio Return Channel** if available. If your TV does not have an HDMI ARC connector, see page 13.

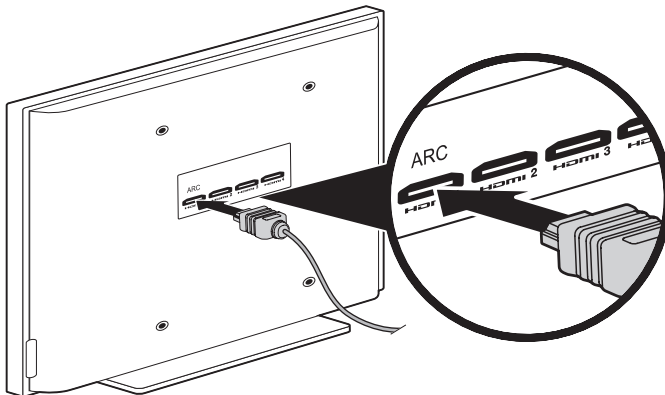

TVs without an HDMI™ ARC connector

If your TV does not have an HDMI ARC connector, you may need to make a secondary connection to the console with an optical, coaxial or analog stereo audio cable. Without this secondary connection, you may not hear audio from the Bose® system.

Use a secondary connection in the following configurations

- You are using internal sources (such as Internet applications or an over-the-air antenna).
- You are connecting sources to your TV.

Refer to your TV owner's guide for more information.

Tip: If your TV has IN and OUT audio connector panels, use audio **OUT** for your secondary connection.

Connecting the console to other sources

You can connect the console to other sources, such as a cable/satellite box, DVD or Blu-ray Disc™ player or game system with an HDMI cable (available separately). If your source is non-HDMI compatible, use different audio and video cables (see page 14).

1. Insert one end of an HDMI cable into your source's HDMI (OUT) connector.
2. Insert the other end of an HDMI cable into the appropriate HDMI connector on the console. For example, to connect a game system, connect an HDMI cable to the **GAME** connector.

Connect other sources to the appropriate HDMI connector on the console.

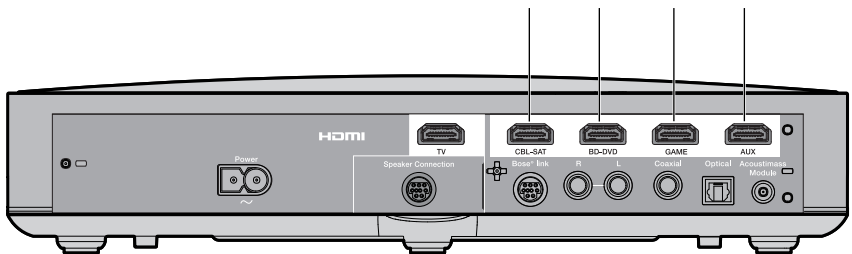

Setting Up the Console

Connecting to non-HDMI™ compatible sources

If your source is non-HDMI compatible, connect it to your TV using audio and video cables (available separately). Refer to your TV owner's guide for more information.

Tip: If your source has IN and OUT audio connector panels, use audio **OUT**.

Audio-only sources

If your audio-only source, such as a media or CD player, is non-HDMI compatible, connect it to the console's optical, coaxial or analog connector. You can use an optical, coaxial or analog cable (available separately).

Note: After connecting your audio-only source, you must set the optical, coaxial or analog input for the appropriate source. You can access these settings using the System menu (see page 27).

Connecting the soundbar

1. Insert one end of the speaker cable into the **Speaker Connection** connector on the console.

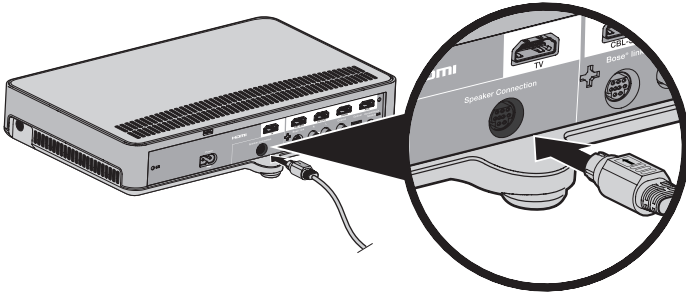

2. Insert the other end of the speaker cable into the **Audio IN** connector on the soundbar.

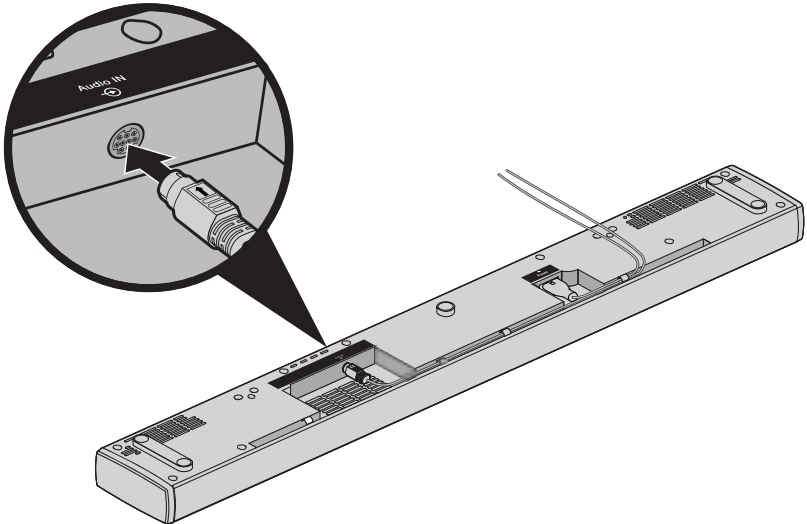

Setting Up the Soundbar

Attaching the optional extension feet to the soundbar

Attach the optional extension feet to raise the soundbar to create space underneath.

1. Turn the soundbar upside down onto a soft surface to protect it from being damaged.
2. Attach the extension feet to the bottom of the soundbar.

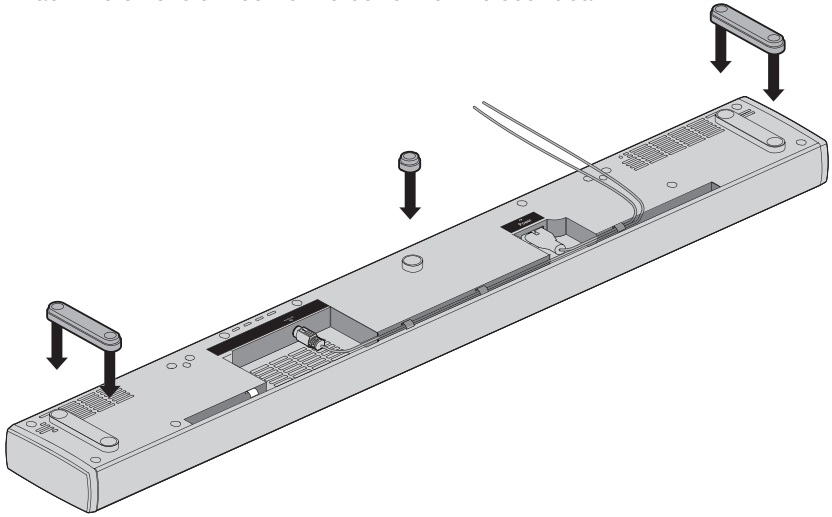

3. Place the soundbar on its feet.

Wall mounting the soundbar

You can mount the soundbar on a wall. To purchase the WB-135 Wall Mount Kit, contact your local Bose dealer or visit www.Bose.com

CAUTION: Do not use any other hardware to mount the soundbar.

Connecting the System to Power

Connecting the soundbar to power

1. Plug the power cord into the **Power** connector on the soundbar.

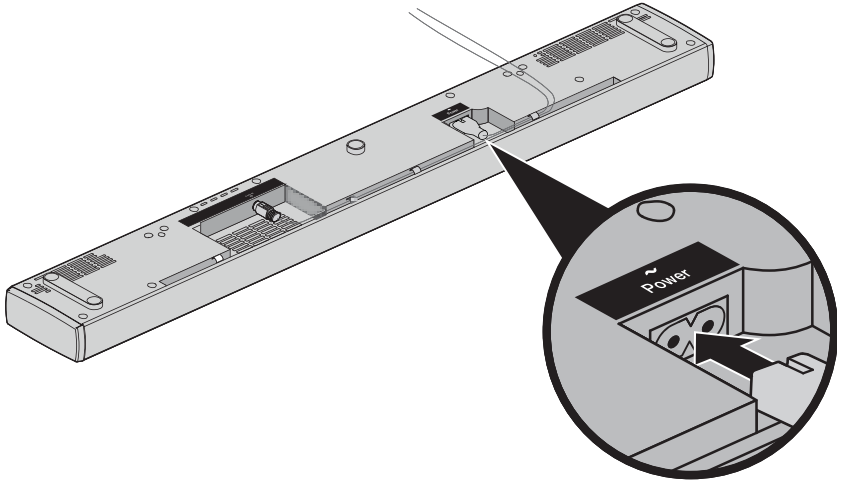

2. Plug the power cord into an AC (mains) outlet.

Connecting the console to power

1. Plug the power cord into the **Power** connector on the console.

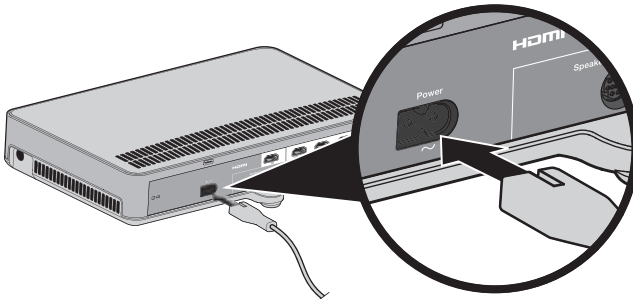

2. Plug the power cord into an AC (mains) outlet.

Starting Up the System

Installing the remote control's batteries

1. Slide open the battery compartment cover on the back of the remote control.

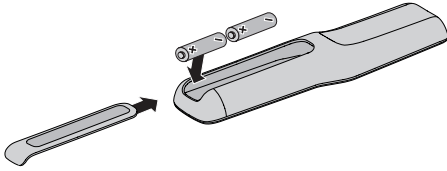

2. Insert the two provided AA (IEC-LR6) 1.5V batteries. Match the + and – symbols on the batteries with the + and – markings inside the compartment.
3. Slide the battery compartment cover back into place.

Powering on the system

Press  on the remote.

The console powers on.

The display defaults to **CBL SAT** for first time power on. Otherwise, the display defaults to your last used source.

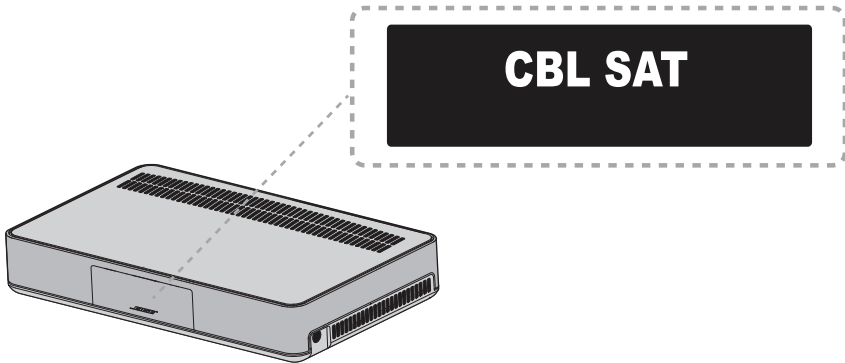

Note: The system powers off after sixteen minutes of inactivity. You can disable AUTO OFF using the System menu (see page 27).

Checking for sound

1. Power on your TV.
2. If you are using a cable/satellite box or other secondary source, power on this source.



Tip: If your secondary source is connected to your TV, select the appropriate TV input. You may need to use a different remote.
3. Power on the system.
4. Press the appropriate source button.
5. Check if sound is coming from the soundbar.

Note: If you do not hear sound from the soundbar, see “Troubleshooting” on page 30.
6. Press  on the remote control. Check that no sound is coming from the TV speakers.



Note: If you hear sound coming from your TV speakers, see “Troubleshooting” on page 30.

Changing the language on the console

Use the remote control to change the language on the console.

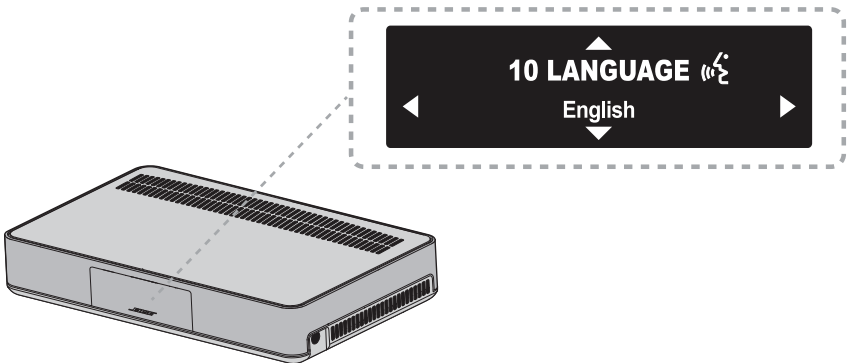
1. Power on the system.
2. Press  on the remote control.
3. Press  until **10 LANGUAGE**  appears on the display.



4. Press  and  to select your language.
5. Press .

Tip: Look for the  icon in the System menu if you select the wrong language.

Finishing Setup





Running the ADAPTiQ® audio calibration

The ADAPTiQ audio calibration customizes the sound of the system to the acoustics of your listening area by taking five audio measurements. To perform an audio calibration, you need 10 minutes when the room is quiet.

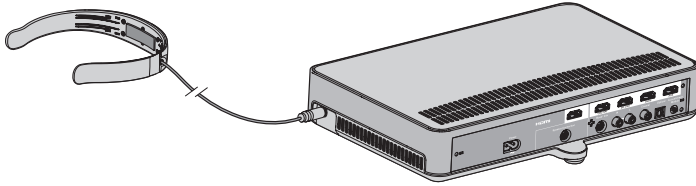
1. Put the ADAPTiQ headset on your head.

During the ADAPTiQ audio calibration, a microphone on the top of the headset measures the sound characteristics of your room to determine optimal sound quality.



2. Insert the ADAPTiQ headset cable into the  connector on the console.
3. Press  on the remote control.
4. Press  until **14 ADAPTiQ** appears on the display.
5. Press .
6. Follow the voice prompts until the system completes the process.
7. Unplug the ADAPTiQ headset from the console and store it in a safe place.

Note: If you move the system or any furniture, run ADAPTiQ again to ensure optimal sound quality.

Remote control buttons

Use the remote to control sources connected to your system, adjust the system volume, change channels, use playback functions, enable cable/satellite box functions and navigate the System menu.

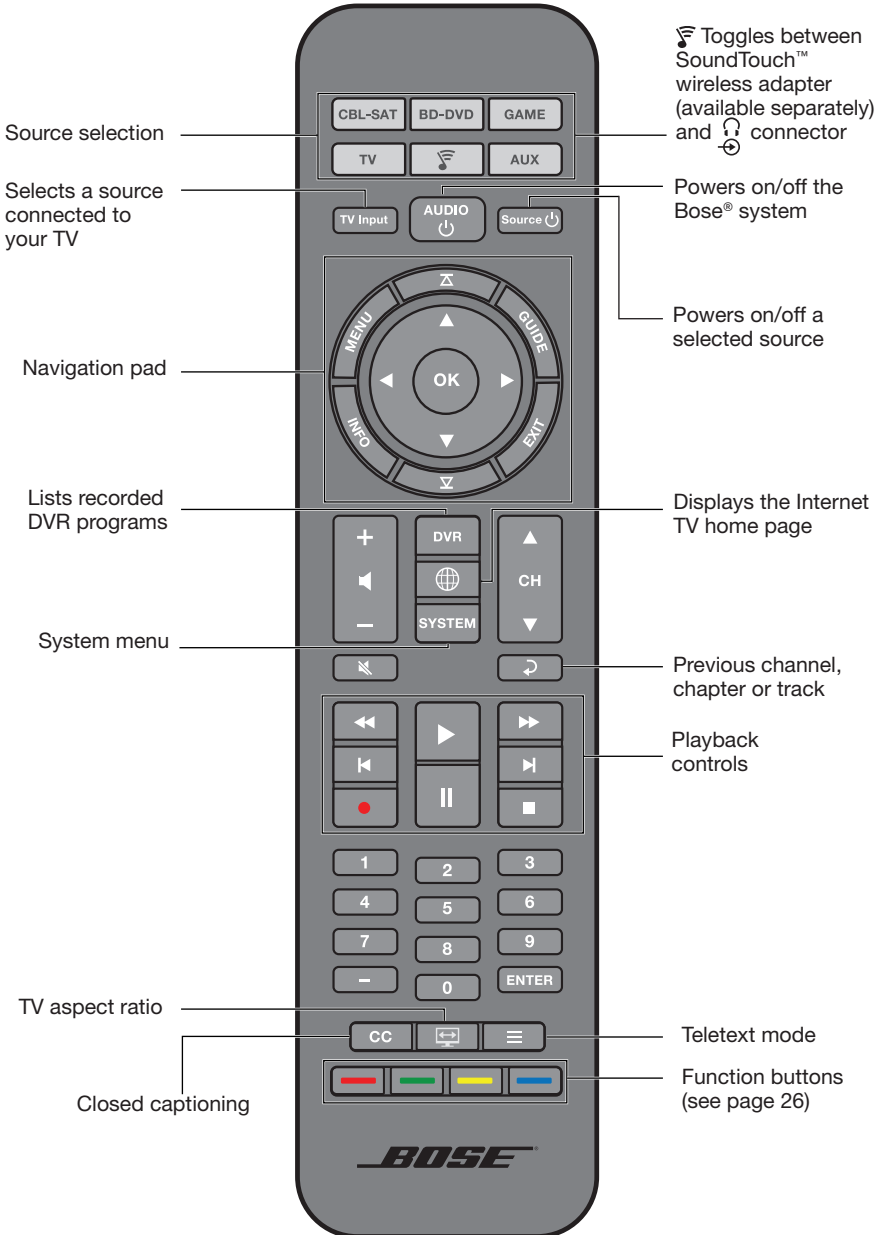

Using the System

Programming the universal remote control

You can use the remote to control your TV, cable/satellite box, DVD or Blu-ray Disc™ player, game system, DVR or other auxiliary source.

Consumer Electronics Control

The system supports Consumer Electronics Control (CEC). CEC allows you to control multiple HDMI™-connected sources without programming the remote. You can turn on/off CEC using the System menu (see page 27).

Your source may support CEC, but refer to it with a different name. Refer to your source owner's guide for more information.

CEC controls sources connected to the console's HDMI connectors.

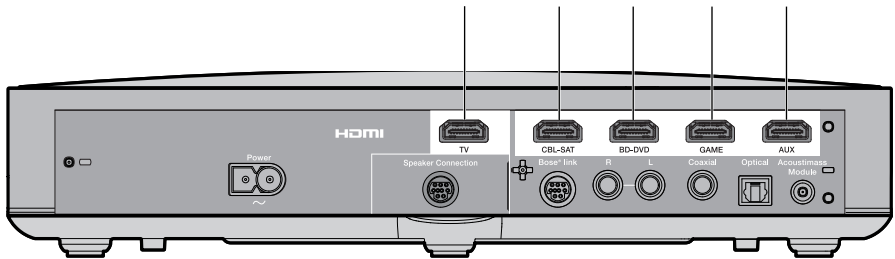

Tip: You may need to use your source's system menu to enable CEC. Refer to your source owner's guide for more information.

Test your HDMI™-connected sources for CEC

Test each of your sources for CEC using the remote control.

Note: Your HDMI-connected source may not support CEC. Refer to your source owner's guide for more information.

1. Power off the Bose® system.
2. Prepare your source:
 - If you are testing your TV, power off your TV.
 - If you are testing another source, power off the source. Power on your TV.
3. Press the button for the source you are testing.



The source button glows. The source and system power on.

4. To ensure your source works properly with your remote control, press a variety of buttons that correspond with your source's functions.

If your source does not perform one of the functions, program the remote control (see page 24).

Using the System

Program the remote to control your source

If your source does not support CEC, you can program the remote to control your source.

1. Power on your source.
2. Locate the code for your source's brand in the *Universal Remote Device Codes* book (provided).

3. On the remote control, press and hold the appropriate source button until all six source buttons glow, then release.

For example, to program your TV, press and hold .

Only the appropriate source button glows.

4. On the number keypad, enter the code for your source's brand.

Note: If all six buttons blink three times, you entered an invalid code.
Repeat steps 3 and 4.

5. Press + on the volume button.

6. Test the source for basic functions:

- **TV:** press the channel buttons. Press . The settings menu appears. Press ◀ and ▶ to navigate.

- **Cable/satellite box:** press . The programming guide appears. Press ◀ and ▶ to navigate.

- **DVD or Blu-ray Disc™ player:** press . The settings menu appears. Press ◀ and ▶ to navigate.

- **Game system:** press ◀ and ▶ to navigate through your menu.

7. If your source responds to basic functions, press  to save your settings.

If your source does not respond

Use the remote control's code scanner to find the code for your source.

1. Press + on the volume button to try another code.

Note: If all six buttons blink three times, you have cycled through all codes for your source.

2. Test the source for basic functions (see step 6 in "Program the remote to control your source").

3. Repeat steps 1 and 2 until your source responds.

4. Press  to save your settings.

Note: Your source may not be compatible with universal remote controls. Refer to your source owner's guide for more information.

Source selection

You can switch between sources by pressing the appropriate source button on the remote control. Before you begin, program the remote to control your source (see page 24).

Select a source connected to the Bose® system

If your source is connected to the console and does not use CEC, follow this procedure to set the console to the appropriate mode and turn on the source.

1. Power on the system.
2. Press the button for the source you want to control.

The source button glows.

3. Press .

The source powers on.

Select a source connected to your TV

If your source is connected to your TV, follow this procedure to select the appropriate TV input.

1. Power on the system, your TV and the appropriate source.
2. Press  to select the correct input on your TV.

You may need to press  several times to select the TV input for the source.

On some TVs,  displays a menu. Use the remote control to choose the correct TV input and close this menu.

Universal source buttons and console connectors

The source buttons on your remote control correspond with the connectors on the back of the console. For example,  corresponds with the **BD-DVD** HDMI™ connector.

Your source buttons work with any source that is connected to the corresponding connector. If you have a secondary DVD or Blu-ray Disc™ player and connect it to the **CBL-SAT** connector, it can be programmed to work with .

If you are using the optical, coaxial, or analog connectors, you must set the input for the appropriate source. You can access these settings using the System menu (see page 27).

Using the System

Adjusting the volume

On the remote control:

- Press + to increase the volume.
- Press – to decrease the volume.
- Press  to mute or unmute the audio.

Note: If you hear sound coming from your TV, see “Troubleshooting” on page 30.

Function buttons

The red, green, yellow and blue buttons on the remote control correspond with the color-coded function buttons on your cable/satellite box or teletext functions.

- Cable/satellite box functions: refer to your cable/satellite box owner’s guide.
- Teletext functions: correspond with color-coded page numbers, headings or shortcuts on a teletext display.

Programming a non-Bose remote control

You can program a non-Bose remote control, such as your cable/satellite box remote, to control the system. Refer to your non-Bose remote control owner’s guide or cable/satellite website for instructions.

Once programmed, the non-Bose remote controls basic functions such as power on/off and volume.



Getting System Information from the Display



Understanding messages on the display

The display on the front of the console allows you to access the System menu and shows system information and icons.

Using the System menu

Use the System menu to adjust audio levels, turn on/off features (such as AUTO OFF), change the language, set the coaxial, analog and optical inputs for a particular source, run ADAPTIQ®, pair your Acoustimass® module with the console or factory reset the system.

1. Press  on the remote.
2. Press ▲ and ▼ to scroll through the System menu.
3. Press ◀ and ▶ to adjust the settings.
4. Press .

Display	System state
1 AUDIO COMP	Off: (Default) No change to audio track. Enhance dialogue: Increases the level of dialogue and sound effects at low volume settings while providing full audio impact at high volume settings. Smart volume: Reduces the range of volume levels in a movie soundtrack so the difference between extremely loud outbursts and soft sounds is less noticeable.
2 AUDIO/VIDEO SYNC	Adjusts the audio delay to synchronize audio and video.
3 HDMI-CEC	On: (Default) Enables CEC (see page 22). Off: Disables CEC.
4 AUTO OFF	Enable: (Default) The system powers off after sixteen minutes of inactivity (no sound coming from the system). Disable: The system will not automatically power off.
5 SIDE AUX	Audio in: (Default) Sets the  connector for an auxiliary source. Headphones: Sets the  connector as a headphones input. Note: If set to Headphones input and a cable is connected, the soundbar is muted. Disconnect your headphones when not in use.
6 BASS LEVEL	Adjusts bass level.
7 TREBLE LEVEL	Adjusts treble level.
8 CENTER LEVEL	Increases or decreases the level of dialogue for movies and TV.

Getting System Information from the Display

Display	System state
9 SURROUND LEVEL	NOT AVAILABLE.
10 LANGUAGE 	Changes the language on the console and ADAPTiQ®.
11 SET OPTICAL INPUT	Sets the optical connector to Auto/TV (Default), CBL SAT, BD DVD, GAME or AUX source.
12 SET COAXIAL INPUT	Sets the coaxial connector to Auto/TV (Default), CBL SAT, BD DVD, GAME or AUX source.
13 SET ANALOG INPUT	Sets the analog connector to Auto/TV (Default), CBL SAT, BD DVD, GAME or AUX source.
14 ADAPTIQ	Starts the ADAPTIQ audio calibration process.
15 PAIR ACOUSTIMASS	Reconnects the Acoustimass® module to the system.
16 FACTORY RESET	Sets the System menu and ADAPTIQ to the factory settings.

Getting System Information from the Display

Error messages

Display	System state
ERROR Cannot find Acoustimass	The Acoustimass® module is not connected to the console.
ERROR Cannot find soundbar	The soundbar is not connected to the console.
<SOURCE> No signal	The source is not connected to the console, or the source is connected to the console and powered off.
SIDE AUX Nothing connected	The source is not connected to the  connector on the console.
ERROR Call Bose	Call Bose® customer service. Refer to the contact sheet in the carton.



Acoustimass module status indicator

The status indicator on the back of the Acoustimass module provides information on system activity.

Indicator activity	Acoustimass module state
Amber	Connected to the console.
Blinking amber	Disconnected from the console.
Slow blinking amber	Available to make a wireless connection to the console.
Red	System error.

Care and Maintenance



Troubleshooting

Problem	What to do
No power	<ul style="list-style-type: none">• Secure the Acoustimass® module's, soundbar's and console's power cords.• Reconnect the Acoustimass module's, soundbar's and console's power cords firmly into an AC (mains) outlet.• Use the remote control to power on the system.• Factory reset the system (see page 32).
No sound	<ul style="list-style-type: none">• Unmute the system.• Increase the volume.• Plug the Acoustimass module, soundbar and console into a live AC (mains) outlet.• Insert the speaker cable into the Speaker Connections connector, not the Bose® Link connector.• Insert the HDMI™ cable into a connector on your TV labeled ARC or Audio Return Channel. If your TV does not have an HDMI ARC connector, use a secondary audio cable in addition to the HDMI cable (see page 13).• If using a secondary audio cable, insert the cable into a connector on your TV labeled Output or OUT, not Input or IN.• Secure all cable connections on the soundbar, TV and connected sources.• If your source is connected to your TV, select the correct TV input (see page 25).• Disconnect headphones when not in use.• If connecting your source through the  connector, enable Audio in using the System menu (see page 27).• If you are connecting headphones to the  connector, enable Headphones using the System menu (see page 27).• If you see the error message Cannot find Acoustimass, pair the Acoustimass module with the console (see page 31).• Factory reset the system (see page 32).
Sound is coming from your TV speakers	<ul style="list-style-type: none">• Insert the HDMI cable into a connector on your TV labeled ARC or Audio Return Channel (if available).• Turn off your TV speakers (refer to your TV owner's guide).• Decrease your TV volume to its lowest setting.
Remote control is inconsistent or does not work	<ul style="list-style-type: none">• Match the + and – symbols on the batteries with the + and – markings inside the compartment (see page 18).• Replace the battery (see page 18).• Press the volume button on the remote control and see if the correct source button flashes.• If using CEC:<ul style="list-style-type: none">- Point the remote control at the console.- Program the remote to control your source (see page 24).• If you have programmed the remote to control your source:<ul style="list-style-type: none">- Point the remote control at the appropriate source.- Ensure you have entered the correct code for your source's brand.- Program the remote with another code (see page 24).

Problem	What to do
Poor or distorted sound	<ul style="list-style-type: none"> Remove all protective films from the system. Secure all cable connections on the soundbar, TV, and connected sources. If you see the error message Cannot find Acoustimass: <ul style="list-style-type: none"> Plug in the Acoustimass® module. Pair the Acoustimass module with the console (see “If your console cannot find the Acoustimass® module”). If using the analog or  connector, decrease the volume on your source. Factory reset the system (see page 32) and run the ADAPTiQ® audio calibration (see page 20).
Intermittent sound	<ul style="list-style-type: none"> Secure all cable connections on the soundbar, TV, and connected sources. Move system away from potential interference, such as a wireless router, cordless phone, television, microwave, etc.

If your console cannot find the Acoustimass® module

The Acoustimass module and console are paired at the factory. However, if you see the error message **Cannot find Acoustimass** on the display, perform this pairing procedure:

1. Unplug the Acoustimass module.
2. Press  on the remote control.
3. Press  until **15 PAIR ACOUSTIMASS** appears on the display.
4. Press .
Plug in Acoustimass appears on the display.
5. Plug the AC power cord into an AC (mains) outlet.

After the Acoustimass module connects to the console, **Pairing complete** appears on the display.

Care and Maintenance

Factory reset the system

To troubleshoot problems, reset the System menu and ADAPTiQ® to the factory settings.

1. Press **SYSTEM** on the remote control.
2. Press **▼** until **16 FACTORY RESET** appears on the display.
3. Press **5**.
The system resets.
4. Run the ADAPTiQ audio calibration (see page 20).

Reset a source button on the remote control

If you are experiencing problems with a source button on the remote control, reset the source button to the factory settings.

After performing this procedure, your source button is in CEC mode.

1. On the remote control, press and hold the appropriate source button until all six source buttons glow, then release.
Only the appropriate source button glows.
2. On the number keypad, enter **0140**.

Service connectors on the Acoustimass® module

The Service and Data connectors are for service use only. Do not insert any cables into these connectors.

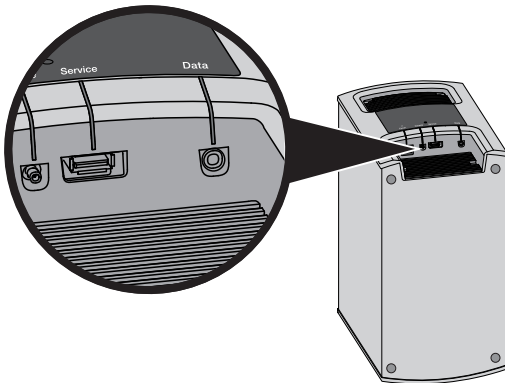

Cleaning

- Clean the surface of the system with a soft, dry cloth.
- Do not use any sprays near the system. Do not use any solvents, chemicals, or cleaning solutions containing alcohol, ammonia or abrasives.
- Do not allow liquids to spill into any openings.

Customer service

For additional help, contact Bose® Customer Service. Refer to the contact sheet in the carton.

Limited warranty

Your system is covered by a limited warranty. Details of the limited warranty are provided on the product registration card that is in the carton. Please refer to the card for instructions on how to register. Failure to register will not affect your limited warranty rights.

The warranty information provided with this product does not apply in Australia and New Zealand. See our website at www.Bose.com.au/warranty or www.Bose.co.nz/warranty for details of the Australia and New Zealand warranty.

Technical information

Acoustimass® module

Power rating: 100-240V ~ 50/60Hz 150W

Console

Power rating: 100-240V ~ 50/60Hz 60W

Soundbar

Power rating: 100-240V ~ 50/60Hz 60W



715117-0010

BOSE[®]

©2014 Bose Corporation, The Mountain,
Framingham, MA 01701-9168 USA
AM715117 Rev. 00